

SPECIFICATION

**TESTED
TO EXTREMES**



TRACKED EXCAVATORS | 370X

Max operating weight: 39735kg Max engine power: 240kW (322hp) Max bucket capacity: 2.34m³



TESTED TO EXTREMES

No stone has been left unturned in the development of the JCB 370X – it's a machine that's been tested to extremes. Every element of this 37 tonne excavator is designed to deliver exceptional performance, safety, comfort and reliability, so you can be sure it's up to the challenge of the biggest, toughest projects.



EXCEPTIONAL PERFORMANCE

We've enhanced the engine, refined the hydraulics and added a host of advanced features to maximise productivity and help you get the job done efficiently.



EXTREME STRENGTH

The 370X needs to be strong enough to meet the demands of any application. That's why it's undergone an extensive 4-year testing programme for ultimate strength and reliability.

EXEMPLARY SAFETY

Your safety matters. That's why we offer a twin camera, ROPS cabin protection and LED work lights as standard.



EXCEEDINGLY COMFORTABLE & EASY

We've put the operator first and made the 370X even more comfortable with many new cab features, with high quality injection moulded interior and fully-adjustable seat.

EXTREMELY COST-EFFECTIVE

Engine and hydraulic enhancements enables the 370X to move material faster and more efficiently. Longer service schedules mean a lower total cost of ownership too.

JCBUX

We've updated our spacious, class-leading JCB CommandPlus cab to give you even more comfort and control by introducing JCB UX. A new 10" full colour touch screen display, updated switchgear and new keyless start make operating easier and faster than ever, while a revised menu interface give you the ability to control functions via multiple inputs, for more productive and efficient working.



SPECIFICATION 370X LC, 370X NLC

STATIC DIMENSIONS

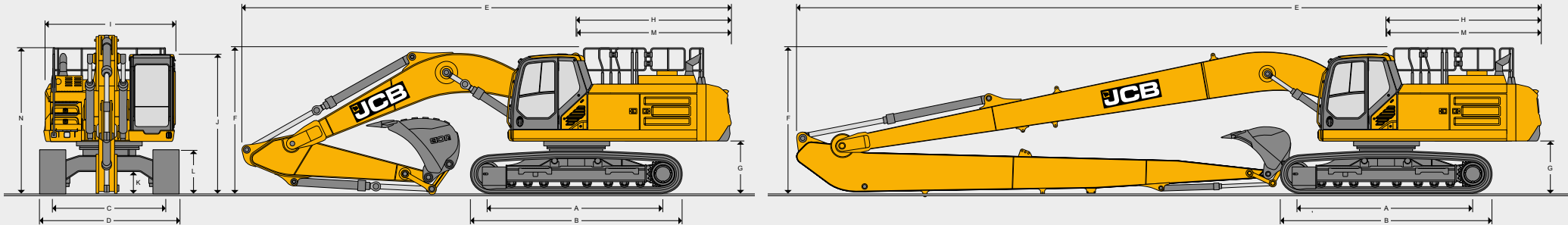

Model			LC		NLC
A	Track length on ground	mm	4021		4021
B	Undercarriage overall length	mm	4965		4965
C	Track gauge	mm	2600		2390
D	Width over tracks (600mm trackshoes)	mm	3200		2990
D	Width over tracks (700mm trackshoes)	mm	3300		3090
D	Width over tracks (800mm trackshoes)	mm	3400		3190
D	Width over tracks (900mm trackshoes)	mm	3500		3290
G	Counterweight clearance	mm	1222		1222
H	Tail length	mm	3550		3550
I	Overall width of superstructure	mm	2990		2990
J	Height over cab	mm	3230		3230
K	Ground clearance	mm	538		538
L	Track height	mm	1036		1036
M	Tail swing radius	mm	3600		3600
N	Overall height of upper structure (height over grab rail)	mm	3381		3381
			Mono 6.45m		LR 12.33m
Dipper lengths			2.63m	3.23m	4.03m
E	Transport length	mm	11338	11224	11301
F	Transport height	mm	3850	3462	3856

ENGINE

Model	Cummins L9 Stage V compliant
Type	4 stroke, 6 cylinder in-line, direct injection, turbocharged diesel
Rated gross power (ISO 14396)	232 kW (310 hp) @ 2100 rpm
Max gross power (ISO 14396)	240 kW (322 hp) @ 1700 rpm
Piston displacement	8.9 litres
Air filtration	Dry element with in cab warning indicator
Starting system	24 volt
Batteries	2 x 12 volt, 1000 CCA
Alternator	24 volt - 120 ampere
Maximum torque	1526 Nm @ 1400 rpm

SWING SYSTEM

Swing motor	Axial piston type
Swing brake	Hydraulic braking plus automatic spring applied disc type parking brake
Swing torque	129 kNm
Swing speed	9.1 rpm
Swing gear	Large diameter, internally toothed fully sealed grease bath lubricated
Swing lock	Switchable brake in cab

SPECIFICATION 370X LC, 370X NLC

UNDERCARRIAGE				
Carriage options	LC – Long Carriage and NLC – Narrow Long Carriage			
Construction	Fully welded 'X' frame type with central belly guarding and sloping side members with dirt relief holes under top rollers			
Recovery point	Front and rear			
Upper and lower rollers	Heat treated, sealed and lubricated			
Track adjustment	Grease cylinder type			
Track idler	Sealed and lubricated, with spring cushioned recoil			
Track type	Sealed and lubricated			
Track shoe options	600mm	700mm	800mm	900mm
	LC	LC	LC	LC
	NLC			
	LC, NLC			
No. of upper rollers (per side)	2			
No. of lower rollers (per side)	9			
No. of track guides (per side)	2			
No. of track shoes (per side)	48			

TRACK DRIVE	
Type	Fully hydrostatic, two-speed with autoshift
Travel motors	Variable swash axial piston type, fully guarded within undercarriage frame
Final drive	Planetary reduction, bolt-on sprockets
Service brake	Hydraulic counter balance valve
Park brake	Disc type, spring applied, automatic hydraulic release
Gradeability	70% (35°) continuous
Travel speed	High – 5.1 km/h Low – 3.0 km/h
Tractive effort	285kN

HYDRAULIC SYSTEM				
Pumps				
Main pumps	2 variable displacement axial piston type			
Maximum flow	2 x 302 l/min			
Servo pump	Gear type			
Maximum flow	17 l/min			
Control valve				
A combined four and five spool control valve with auxiliary service spool as standard.				
Relief valve settings				
Boom/Arm/Bucket	350 bar			
With power boost	380 bar (Mono) 350 bar (LR)			
Swing circuit	292 bar			
Travel circuit	350 bar			
Pilot control	40 bar			
Filtration				
In tank	105 micron, suction strainer			
Main return line	10 micron, glass fibre element			
Pilot line	10 micron, glass fibre element			
Hydraulic hammer return	10 micron, reinforced microform element			
Hydraulic cylinders				
	Quantity	Bore mm	Rod diameter mm	Cylinder Stroke mm
Boom	2	150	100	1480
Arm	1	170	120	1822
Bucket	1	150	105	1275
LR Bucket	1	105	75	997
SERVICE CAPACITIES				
Fuel tank	Litres	590		
Engine coolant	Litres	41		
Engine oil	Litres	24.5		
Swing reduction gear	Litres	16		
Track reduction gear (each side)	Litres	4.5		
Hydraulic system	Litres	400		
Hydraulic tank	Litres	175		
DEF fluid	Litres	73.6		

SPECIFICATION 370X LC, 370X NLC

WEIGHTS AND GROUND BEARING PRESSURES

2.1m³ bucket 1946kg, operator 75kg, full fuel tank and 2.63m HD dipper

		600mm Triple Grouser	700mm Triple Grouser	800mm Triple Grouser	900mm Triple Grouser	600mm Double Grouser
370X LC MonoBoom						
Machine weight	kg	38248	38710	39170	39632	38354
Ground bearing pressure	kg/cm ²	0.79	0.69	0.61	0.55	0.80

370X NLC MonoBoom

Machine weight	kg	38094	38556	39016	39478	38200
Ground bearing pressure	kg/cm ²	0.79	0.69	0.61	0.55	0.79

2.1m³ bucket 1946kg, operator 75kg, full fuel tank and 3.23m std dipper

		600mm Triple Grouser	700mm Triple Grouser	800mm Triple Grouser	900mm Triple Grouser	600mm Double Grouser
370X LC MonoBoom						
Machine weight	kg	38269	38731	39191	39653	38375
Ground bearing pressure	kg/cm ²	0.79	0.69	0.61	0.55	0.80

370X NLC MonoBoom

Machine weight	kg	38115	38577	39037	39499	38221
Ground bearing pressure	kg/cm ²	0.79	0.69	0.61	0.55	0.79

2.1m³ bucket 1946kg, operator 75kg, full fuel tank and 3.23m HD dipper

		600mm Triple Grouser	700mm Triple Grouser	800mm Triple Grouser	900mm Triple Grouser	600mm Double Grouser
370X LC MonoBoom						
Machine weight	kg	38351	38813	39273	39735	38457
Ground bearing pressure	kg/cm ²	0.80	0.69	0.61	0.55	0.80

370X NLC MonoBoom

Machine weight	kg	38197	38659	39119	39581	38303
Ground bearing pressure	kg/cm ²	0.79	0.69	0.61	0.55	0.79

2.1m³ bucket 1946kg, operator 75kg, full fuel tank and 4.03m std dipper

		600mm Triple Grouser	700mm Triple Grouser	800mm Triple Grouser	900mm Triple Grouser	600mm Double Grouser
370X LC MonoBoom						
Machine weight	kg	38504	38966	39426	39888	38610
Ground bearing pressure	kg/cm ²	0.80	0.69	0.61	0.55	0.80

370X NLC MonoBoom

Machine weight	kg	38350	38812	39272	39734	38456
Ground bearing pressure	kg/cm ²	0.80	0.69	0.61	0.55	0.80

0.79m³ bucket 545kg, operator 75kg, full fuel tank

		600mm Triple Grouser	700mm Triple Grouser	800mm Triple Grouser	900mm Triple Grouser	600mm Double Grouser
370X LC Long Reach						
Machine weight	kg	41554	42016	42476	42938	41660
Ground bearing pressure	kg/cm ²	0.86	0.75	0.66	0.59	0.86

BUCKET AND ARM COMBINATION

		915	1372	1524	1753	1873	900	1350	1500	1750	1650	1800	2200	2500
Bucket width	mm	915	1372	1524	1753	1873	900	1350	1500	1750	1650	1800	2200	2500
Bucket capacity	m ³	0.81	1.39	1.58	1.87	2.01	0.86	1.43	4.62	1.93	2.1	2.34	1.71	1.96
Bucket weight	kg	810	1037	1123	1245	1300	928	1192	1271	1431	1946	2059	1132	1256

370X LC

2.63m HD Quickhitch (No Quickhitch)		☐ (X)	☐ (X)	☐ (X)	☐ (X)	☐ (X)	☐ (X)	☐ (X)	☐ (X)	☐ (X)	☐ (☐)	■ (☐)	☐ (X)	☐ (X)
3.23m STD Quickhitch (No Quickhitch)		☐ (X)	☐ (X)	☐ (X)	☐ (X)	☐ (X)	☐ (X)	☐ (X)	☐ (X)	☐ (X)	■ (☐)	■ (☐)	☐ (X)	☐ (X)
3.23m HD Quickhitch (No Quickhitch)		☐ (X)	☐ (X)	☐ (X)	☐ (X)	☐ (X)	☐ (X)	☐ (X)	☐ (X)	☐ (X)	■ (☐)	● (■)	☐ (X)	☐ (X)
4.03m STD Quickhitch (No Quickhitch)		☐ (X)	☐ (X)	☐ (X)	☐ (X)	☐ (X)	☐ (X)	☐ (X)	☐ (X)	☐ (X)	● (●)	● (●)	☐ (X)	■ (X)

370X NLC

2.63m HD Quickhitch (No Quickhitch)		☐ (X)	☐ (X)	☐ (X)	☐ (X)	☐ (X)	☐ (X)	☐ (X)	☐ (X)	☐ (X)	■ (☐)	● (■)	☐ (X)	☐ (X)
3.23m STD Quickhitch (No Quickhitch)		☐ (X)	☐ (X)	☐ (X)	☐ (X)	☐ (X)	☐ (X)	☐ (X)	☐ (X)	☐ (X)	■ (☐)	● (■)	☐ (X)	☐ (X)
3.23m HD Quickhitch (No Quickhitch)		☐ (X)	☐ (X)	☐ (X)	☐ (X)	■ (X)	☐ (X)	☐ (X)	☐ (X)	■ (X)	● (■)	● (■)	☐ (X)	☐ (X)
4.03m STD Quickhitch (No Quickhitch)		☐ (X)	☐ (X)	☐ (X)	■ (X)	☐ (X)	☐ (X)	☐ (X)	■ (X)	● (X)	× (●)	× (●)	■ (X)	■ (X)

- ☐ = Suitable for general excavating materials up to 2000kg/m³.
- = Suitable for light excavating materials up to 1600kg/m³.
- = Suitable for grading and loading materials up to 1200kg/m³.
- (X) = Not compatible

These recommendations are given as a guide based on typical operating conditions. Please contact your distributor for the correct selection of buckets and attachments to suit the application.

SPECIFICATION 370X LC, 370X NLC

WORKING RANGE – MONOBOOM 6.45M

Bucket		XHD Bucket (1800mm)			
Dipper length:		2.63m	3.23m	4.03m	
A	Maximum digging reach (mm)	mm	10763	11319	12056
B	Maximum digging reach (on ground) (mm)	mm	10560	11126	11875
C	Maximum digging depth (mm)	mm	6969	7565	8364
D	Maximum digging height (mm)	mm	10081	10351	10652
E	Maximum dumping height (mm)	mm	6704	6966	7275
F	Maximum vertical wall cut depth (mm)	mm	6205	6824	7561
G	Minimum swing radius (mm)	mm	4547	4482	4436
H	Minimum dumping height (mm)	mm	3022	2424	1626
	Bucket rotation	degrees	185	185	185
	Maximum dipper tearout	kN	222.1	185.6	160.7
	Maximum bucket tearout	kN	249.4	249.4	249.4

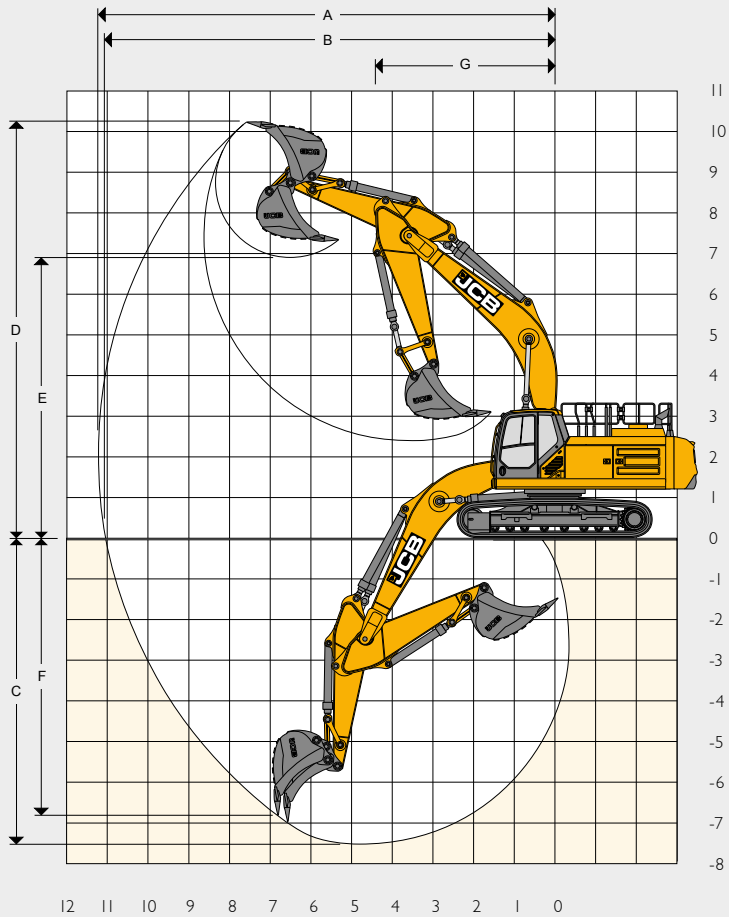

WORKING RANGE – LR 12.33M

Bucket		GP Bucket (600mm)	
Dipper length:		9.5m	
A	Maximum digging reach (mm)	mm	21639
B	Maximum digging reach (on ground) (mm)	mm	21540
C	Maximum digging depth (mm)	mm	17449
D	Maximum digging height (mm)	mm	15478
E	Maximum dumping height (mm)	mm	13162
F	Maximum vertical wall cut depth (mm)	mm	15399
G	Minimum swing radius (mm)	mm	7688
H	Minimum dumping height (mm)	mm	1650
	Bucket rotation	degrees	185
	Maximum dipper tearout	kN	104.2
	Maximum bucket tearout	kN	117.7

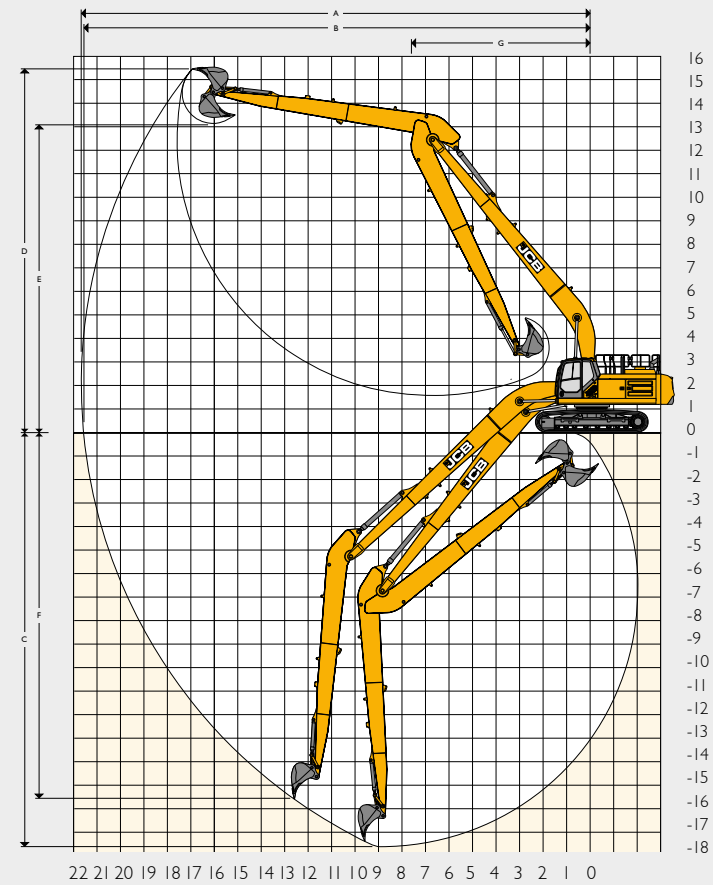

SPECIFICATION 370X LC, 370X NLC

STANDARD/OPTIONAL EQUIPMENT

ENGINE		CAB & INTERIOR		HYDRAULIC SYSTEM	
Cummins L9 Stage V compliant	•	Sound-insulated and 4 dual-shock cab mounts	•	Boom and arm flow regeneration	•
Start pre-heat	•	Opening front window and removable lower front window	•	One touch power boost	•
One touch idle	•	Upper door sliding glass	•	Cushion control	•
Auto-idle function	•	Upper windscreen wiper	•	Cylinder cushioning and contamination seals	•
Heavy-duty batteries	•	Dual front wiper	+	2-speed track motors	•
Fuel filter with sediment trap	•	4-button joysticks with customisable hotkeys	•	Oil cooler	•
Electronic engine control	•	Operator profile customisation	•	15 attachments through display	•
Fuel cooler	•	Proportional control joysticks	+	High, merged, medium and low flow options (shut off valves standard)	+
Refuelling pump	•	Travel pedals and T handle levers	•	Advanced tool select to control flow and pressure	+
Refuelling pump filter	+	2 footrests	•	Cold and hot climate and Panolin oils	+
Fuel line drain tap	+	Immobiliser	•	Quickhitch steel pipework	•
SAFETY		Standard cab filtration	•	Hydraulic Quickhitch	+
Side guard rails on upper structure and steps	•	Carbon air filter	+	ISO/SAE change over	+
Rear and side camera	•	Dual tone horn	•	SAE to BSP converters on high flow auxiliary pipework	+
Battery Isolator	•	Interior Cab light	•	Quick release couplings	+
Keyless startup	•	2x 12v sockets	•	Hose burst check valves (boom, arm & bucket)	+
Lockable fuel tank cap	•	10" touchscreen display	•	Boom float	+
Lockable hydraulic tank cap	•	Retractable seatbelt	•	Auxiliary vent to tank	+
LED work lights (2 revolving frame, 2 boom mounted)	•	3" hi-vis seatbelt	+	Attachment case drain	+
ROPS Cabin	•	Fixed roof glass	•	DIG END	
FOPS Level 2 guard – top and front	+	Storage box, Cup Holder, Coat hook, handbook stowage netting	•	Grouped greasing	•
Travel Alarm	•	Premium Cab Upgrade: Coolbox cooling/heating function, right hand armrest rubber lining, additional rear stowage net, coat stay	+	Dippers 2.63m, 3.23m, 4.03m	+
White noise alarm	+	Climate Control	•	HD dippers 2.63m, 3.23m	+
Additional LED lights option – upgrade pack	+	Front Blind	•	Lifting lug tipping link	+
Green beacon linked to seatbelt	+	Roof Blind	•	Lifting sprung hook tipping link	+
Fire extinguisher (1kg) powder	+	Side Blind	+	Bucket ram guard	+
Vandal guards	+	Rear Blind	+	Boom light guards	+
Rotating roof beacon	+	Bluetooth Radio	•	OTHER	
360 degree camera system integrated in display	+	DAB Radio	+	Toolbox storage	•
Full upper structure handrails (boxing ring)	+	Deluxe seat: heated, adjustable air suspension seat with adjustable headrest, mechanical lumbar support	•	Wide core radiator	•
High visibility handrails	+	Super deluxe seat: heated and air ventilation, adjustable air suspension seat with adjustable headrest and electric lumbar support	+	Liveline telematics	•
Arm limiter	+	Rain guard visor	•	Toolkit	+
		UNDERCARRIAGE		Battery storage tray	+
		Greased and sealed track links	•	HD undercovers and belly plates	+
		Twin track guards	•	Service bay lighting	+
		Full length track guards	+	2D and 3D Ready with Intellicontrol	+
		600mm, 700mm, 800mm, 900mm triple grouser shoes	+	Revolving frame side impact protection system	+
		600mm double grouser shoe	+	Shovel storage	+
				Reversing fan	•
				STANDARD	•
				OPTIONAL	+

LIFT CAPACITIES – LC MONO, 3.23M ARM, NO BUCKET, 600 SHOE **370X**

Reach	3m		4.5m		6m		7.5m		9m		Capacity at Max. Reach		
													
Load Point Height	kg	kg	kg	kg	kg	kg	kg	kg	kg	kg	kg	kg	mm
7.5m							8304*	8194			7065*	7065*	7692
6m							9207*	8116			6831*	6452	8577
4.5m					11230*	11041	9797*	7849	8046*	5852	6850*	5708	9130
3m			17334*	15680	12817*	10367	10596*	7508	8586	5704	7081*	5311	9412
1.5m			19724*	14563	14182*	9775	11015	7183	8409	5542	7548*	5163	9446
0m			20390*	14077	14916*	9393	10752	6946	8284	5427	7992	5243	9235
-1.5m	14779*	14779*	19763*	13978	14816	9233	10630	6837			8571	5598	9763
-3m	23298*	23298*	18039*	14115	13822*	9271	10673	6890			9655*	6390	7980
-4.5m	19250*	19250*	14849*	14485	11300*	9538					9385*	8148	6779

LIFT CAPACITIES – LC MONO, 4.03M ARM, NO BUCKET, 600 SHOE **370X**

Reach	3m		4.5m		6m		7.5m		9m		Capacity at Max. Reach		
													
Load Point Height	kg	kg	kg	kg	kg	kg	kg	kg	kg	kg	kg	kg	mm
7.5m											5297*	5297*	8600
6m							7987*	7897*	6989*	5875	5128*	5128*	9399
4.5m							8666*	7780	8023*	5735	5127*	4817	9905
3m			15043*	15043*	11425*	10366	9564*	7379	8424	5524	5272*	4488	10165
1.5m			18033*	14604	13023*	9648	10457*	6981	8185	5304	5574*	4351	10197
0m	9074*	9074*	19577*	13780	14115*	9125	10482	6664	7990	5124	6082*	4390	10002
-1.5m	13633*	13633*	19714*	13461	14425	8842	10270	6473	7885	5028	6910*	4633	9568
-3m	19605*	19605*	18684*	13463	14000*	8776	10224	6432			8104	5175	8858
-4.5m	22549*	22549*	16375*	13717	12407*	8923	9281*	6593			8612*	6287	7796



Lift capacity front and rear.











Lift capacity full circle.

Notes:

1. Lifting capacities are based on ISO 10567, that is: 75% of minimum tipping load or 87% of hydraulic lift capacity, whichever is the less. Lifting capacities marked* are based on hydraulic capacity.
2. Lift capacities assume that the machine is on firm, level ground.
3. Lift capacities may be limited by local regulations. Please refer to your dealer.

SPECIFICATION 370X LC, 370X NLC

LIFT CAPACITIES – NLC MONO, 3.23M ARM, NO BUCKET, 600 SHOE													370X
Reach	3m		4.5m		6m		7.5m		9m		Capacity at Max. Reach		
													
Load Point Height	kg	kg	kg	kg	kg	kg	kg	kg	kg	kg	kg	kg	mm
7.5m							8304*	7567			7065*	7065*	7692
6m							9207*	7490			6831*	5943	8577
4.5m					11230	10150	9797*	7228	8046*	5379	6850*	5244	9130
3m			17334*	14219	12817	9492	10596*	6892	8555	5233	7081*	4869	9412
1.5m			19724*	1319	14182	8913	10975	6573	8379	5073	7548*	4725	9446
0m			20390*	12669	14916	8539	10712	6340	8253	4960	7962	4792	9235
-1.5m	14779*	14779*	19763*	12573	14762	8382	10591	6232			8539	5113	8763
-3m	23298*	23298*	18039*	12706	13822*	8420	10651	6285			9655*	5836	7980
-4.5m	19250*	19250*	14849*	13063	11300*	8681					9385*	7440	6779

LIFT CAPACITIES – NLC MONO, 4.03M ARM, NO BUCKET, 600 SHOE													370X
Reach	3m		4.5m		6m		7.5m		9m		Capacity at Max. Reach		
													
Load Point Height	kg	kg	kg	kg	kg	kg	kg	kg	kg	kg	kg	kg	mm
7.5m												5297*	8600
6m							7987*	7467	6989*	5397	5128*	4953	9399
4.5m							8666*	7153	8023*	5258	5127*	4401	9905
3m			15043*	14554	11425*	9481	9564*	6759	8393	5050	5272*	4089	10165
1.5m			18033*	13166	13023*	8780	10457*	6368	8154	4833	5574*	3955	10197
0m	9074*	9074*	19577*	12369	14115*	8268	10443	6056	7959	4656	6082*	3984	10002
-1.5m	13633*	13633*	19714*	12061	14371	7991	40231	5868	7854	4561	6910*	4203	9568
-3m	19605*	19605*	18684*	12062	14000*	7927	10185	5828			8073	4697	8858
-4.5m	22549*	22549*	16375*	12308	12407*	8070	9281*	5986			8612*	5713	7796















Lift capacity front and rear.



Lift capacity full circle.

Notes:

1. Lifting capacities are based on ISO 10567, that is: 75% of minimum tipping load or 87% of hydraulic lift capacity, whichever is the less. Lifting capacities marked* are based on hydraulic capacity.
2. Lift capacities assume that the machine is on firm, level ground.
3. Lift capacities may be limited by local regulations. Please refer to your dealer.

LIFT CAPACITIES – LC MONO, 2.63M HD ARM, NO BUCKET, 600 SHOE													370X	
Reach	3m		4.5m		6m		7.5m		9m		Capacity at Max. Reach			
														
Load Point Height	kg	kg	kg	kg	kg	kg	kg	kg	kg	kg	kg	kg	mm	
7.5m												9885*	8814	6995
6m					10547*	10547*	9675*	7766				9583*	6994	7959
4.5m			15079*	15079*	11752*	10590	10116*	7520				9205	6066	8553
3m			18271*	14831	13185*	9915	10785*	7192				8548	5589	8853
1.5m					14300*	9371	10727	6894				8348	5420	8890
0m			19829*	13680	14670	9067	10513	6702				8569	5531	8666
-1.5m	14740*	14740*	18679*	13719	14286*	8991	10464	6658				9325	5992	8159
-3m	20706*	20706*	16487*	13960	12801*	9125						9873*	7053	7311
-4.5m	15370*	15370*	12550*	12550*								9148*	9148*	5974

LIFT CAPACITIES – LC MONO, 3.23M HD ARM, NO BUCKET, 600 SHOE													370X	
Reach	3m		4.5m		6m		7.5m		9m		Capacity at Max. Reach			
														
Load Point Height	kg	kg	kg	kg	kg	kg	kg	kg	kg	kg	kg	kg	mm	
7.5m							8129*	7995				6892*	6892*	7692
6m							8949*	7910				6652*	9243	8577
4.5m					10948*	10815	9525*	7629	7859*	5637		6665*	5492	9130
3m			16986*	15380	12510*	10114	10311*	7273	8374	5481		6891*	5091	9412
1.5m			19347*	14227	13856*	9500	10780	6936	8191	5312		7352*	4938	9446
0m			20003*	13731	14580*	9107	10509	6692	8062	5194		7773	5014	9235
-1.5m	14609*	14609*	19378*	13634	14506*	8945	10386	6581				8348	5364	8763
-3m	23138*	23138*	17662*	13780	13489*	8989	10374*	6641				9367*	6151	7980
-4.5m	18820*	18820*	14487*	14169	10981*	9272						9087*	7902	6779



Lift capacity front and rear.



Lift capacity full circle.

Notes:

1. Lifting capacities are based on ISO 10567, that is: 75% of minimum tipping load or 87% of hydraulic lift capacity, whichever is the less. Lifting capacities marked* are based on hydraulic capacity.
2. Lift capacities assume that the machine is on firm, level ground.
3. Lift capacities may be limited by local regulations. Please refer to your dealer.

SPECIFICATION 370X LC, 370X NLC

LIFT CAPACITIES – NLC MONO, 2.63M HD ARM, NO BUCKET, 600 SHOE **370X**

Reach	3m		4.5m		6m		7.5m		9m		Capacity at Max. Reach				
															
Load Point Height	kg	kg	kg	kg	kg	kg	kg	kg	kg	kg	kg	kg	mm		
7.5m												9885*	8115	6995	
6m					10547*	10283			9675*	7142			9583*	6426	7959
4.5m			15079*	14899	11752*	9704			10116*	6901			9172	5557	8553
3m			18271*	13390	13185*	9044			10785*	6578			8517	5107	8853
1.5m					14300*	8512			10688	6285			8317	4942	8890
0m			19829*	12277	14616	8215			10474	6096			8537	5038	8666
-1.5m	14740*	14740*	18679*	12315	14286*	8140			10425	6053			9290	5455	8159
-3m	20706*	20706*	16487*	12548	12801*	8272							9873*	6422	7311
-4.5m	15370*	15370*	12550*	12550*									9148*	8780	5974

LIFT CAPACITIES – NLC MONO, 3.23M HD ARM, NO BUCKET, 600 SHOE **370X**

Reach	3m		4.5m		6m		7.5m		9m		Capacity at Max. Reach				
															
Load Point Height	kg	kg	kg	kg	kg	kg	kg	kg	kg	kg	kg	kg	mm		
7.5m								8129*	7367			6892*	6892*	7692	
6m								8949*	7282			6652*	5732	8577	
4.5m					10948*	9923						6665*	5028	9130	
3m			16986*	13919	12510*	9237			9525*	7007	7859*	5162	6891*	4648	9412
1.5m			19347*	12804	13856*	8637			10311*	6657	8343	5009	6891*	4648	9412
0m			20003*	12325	14580*	8252			10741	6325	8160	4843	7352*	4499	9446
-1.5m	14609*	14609*	19378*	12230	14484	8094			10469	6085	8032	4726	7744	4562	9235
-3m	23138*	23138*	17662*	12372	13489*	8137			10347	5976			8316	4879	8763
-4.5m	18820*	18820*	14487*	12748	10981*	8414			10374*	6035			9367*	5596	7980
													9087*	7192	6779



Lift capacity front and rear.





















Lift capacity full circle.

Notes:

1. Lifting capacities are based on ISO 10567, that is: 75% of minimum tipping load or 87% of hydraulic lift capacity, whichever is the less. Lifting capacities marked* are based on hydraulic capacity.
2. Lift capacities assume that the machine is on firm, level ground.
3. Lift capacities may be limited by local regulations. Please refer to your dealer.

SPECIFICATION 370X LC, 370X NLC

LC LR, 9.5M ARM, NO BUCKET, 600 SHOE																			370X	
Reach	3m		4.5m		6m		7.5m		9m		10.5m		12m		13.5m		Capacity at Max. Reach			
																				
Load Point Height	kg	kg	kg	kg	kg	kg	kg	kg	kg	kg	kg	kg	kg	kg	kg	kg	kg	kg	mm	
13.5m																		1351*	1351*	16759
12m																		1322*	1322*	17700
10.5m																		1311*	1311*	18470
9m																		1315*	1315*	19091
7.5m																		1333*	1333*	19576
6m																		1364*	1364*	19937
4.5m														3310*	3310*	2978*	2978*	1410*	1309	20179
3m			10848*	10848*					4789*	4789*	4064*	4064*	3543*	3543*	3150*	3150*	1471*	1216	20306	
1.5m			6014*	6014*	8600*	8600*	6504*	6504*	5228*	5228*	4377*	4377*	3772*	3604	3322*	2946	1550*	1147	20322	
0m	2620*	2620*	4949*	4949*	9331*	7957	7034*	6145	5612*	4897	4660*	3972	3984*	6255	3483*	2683	1649*	1100	20226	
-1.5m	3454*	3454*	5113*	5113*	8317*	7156	7410*	5487	5913*	4387	4895*	3581	4167*	2955	3623*	2452	1774*	1075	20017	
-3m	4307*	4307*	5688*	5688*	8264*	6723	7629*	5059	6119*	4019	5069*	3279	4307*	2713	3733*	2261	1933*	1073	19690	
-4.5m	5185*	5185*	6454*	6454*	8727*	6525	7702*	4811	6223*	3777	5172*	3066	4396*	2534	3804*	2116	2136*	1098	19241	
-6m	6096*	6096*	7344*	7344*	9493*	6482	7641*	4698	6224*	3642	5196*	2934	4424*	2417	3812	2018	2358	1152	18659	
-7.5m	7052*	7052*	8339*	8339*	9332*	6552	7450*	4688	6120*	3596	5135*	2875	4380*	2359	3760	1969	2509	1244	17932	
-9m	8064*	8064*	9442*	9442*	8824*	6715	7123*	4766	5899*	3626	4974*	2883	4251*	2359	3665*	1971	2570*	1386	17042	
-10.5m	9145*	9145*	10346*	10346*	8135*	6963	6643*	4921	5545*	3728	4696*	2955	4012*	2417	3441*	2027	2618*	1601	15961	
-12m	10305*	10305*	9034*	9034*	7229*	7229*	5977*	5156	5026*	3903	4265*	3094	3628*	2539	3063*	2147	2644*	1931	14645	
-13.5m	9535*	9535*	7370*	7370*	6044*	6044*	5069*	5069*	4288*	4159	3623*	3312	3022*	2742			2617*	2464	13024	
-15m			5235*	5235*	4475*	4475*	3823*	3823*	3225*	3225*	2644*	2644*					2459*	2459*	10961	



Lift capacity front and rear.













Lift capacity full circle.

Notes:

1. Lifting capacities are based on ISO 10567, that is: 75% of minimum tipping load or 87% of hydraulic lift capacity, whichever is the less. Lifting capacities marked* are based on hydraulic capacity.
2. Lift capacities assume that the machine is on firm, level ground.
3. Lift capacities may be limited by local regulations. Please refer to your dealer.

SPECIFICATION 370X LC, 370X NLC

LC LR, 9.5M ARM, NO BUCKET, 600 SHOE											370X
Reach	15m		16.5m		18m		19.5m		Capacity at Max. Reach		
											
Load Point Height	kg	kg	kg	kg	kg	kg	kg	kg	kg	kg	mm
13.5m			1568*	1568*					1351*	1351*	16759
12m			2192*	2192*					1322*	1322*	17700
10.5m			2234*	2234*	1735*	1735*			1311*	1311*	18470
9m			2276*	2276*	2178*	2130			1315*	1315*	19091
7.5m	2487*	2487*	2338*	2338*	2217*	2056	1418*	1418*	1333*	1333*	19576
6m	2595*	2595*	2416*	2416*	2272*	1960	1839*	1541	1364*	1364*	19937
4.5m	2716*	2716*	2506*	2299	2336*	1849	2162*	1466	1410*	1309	20179
3m	2845*	2629	2603*	2139	2406*	1731	2245*	1384	1471*	1216	20306
1.5m	2974*	2416	2700*	1979	2477*	1612	2293*	1300	1550*	1147	20322
0m	3097*	2216	2791*	1827	2543*	1500	2334*	1220	1649*	1100	20226
-1.5m	3204*	2038	2871*	1692	2597*	1399	2299	1151	1774*	1075	20017
-3m	3287*	1889	2930*	1578	2579	1317	2244	1098	1933*	1073	19690
-4.5m	3338*	1775	2893	1493	2518	1258			2136*	1098	19241
-6m	3270	1699	2837	1439	2487	1228			2358	1152	18659
-7.5m	3234	1664	2820	1422					2509	1244	17932
-9m	3172*	1675	2729*	1451					2570*	1386	17042
-10.5m	2935*	1739							2618*	1601	15961
-12m									2644*	1931	14645
-13.5m									2617*	2464	13024
-15m									2459*	2459*	10961



Lift capacity front and rear.



Lift capacity full circle.

Notes:

1. Lifting capacities are based on ISO 10567, that is: 75% of minimum tipping load or 87% of hydraulic lift capacity, whichever is the less. Lifting capacities marked* are based on hydraulic capacity.
2. Lift capacities assume that the machine is on firm, level ground.
3. Lift capacities may be limited by local regulations. Please refer to your dealer.





ONE COMPANY, OVER 300 MACHINES.

Your nearest JCB dealer

TRACKED EXCAVATORS 370X

Max operating weight: 39735kg Max engine power: 240kW (322hp) Max bucket capacity: 2.34m³

JCB Sales Limited, Rokester, Staffordshire, United Kingdom ST14 5JP.
 Tel: +44 (0)1889 590312 Email: salesinfo@jcb.com
 Download the very latest information on this product range at: www.jcb.com

©2023 JCB Sales. All rights reserved. No part of this publication may be reproduced, stored in a retrieval system, or transmitted in any form or by any other means, electronic, mechanical, photocopying or otherwise, without prior permission from JCB Sales. All references in this publication to operating weights, sizes, capacities and other performance measurements are provided for guidance only and may vary dependant upon the exact specification of machine. They should not therefore be relied upon in relation to suitability for a particular application. Guidance and advice should always be sought from your JCB Dealer. JCB reserves the right to change specifications without notice. Illustrations and specifications shown may include optional equipment and accessories. The JCB logo is a registered trademark of J C Bamford Excavators Ltd.

